

# 10" Reversible Lid for Skimmers and Autofillers Instructions

Read, then keep these instructions for future reference.  
For more instructions, please consult your local building codes.

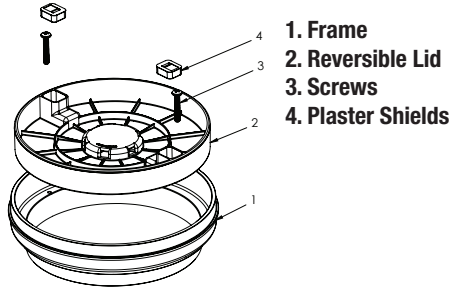

Fits all Waterway skimmers and autofillers and most standard skimmers (Aqua star®, Hayward®, CMP®, Sta-rite® & Pentair®)

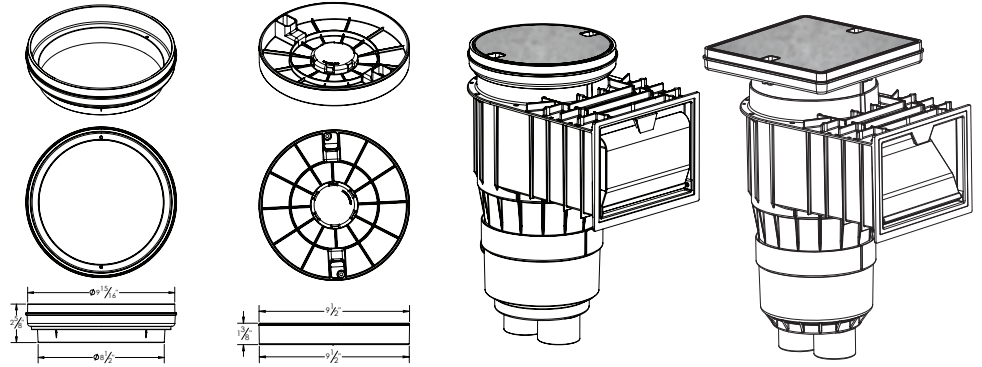

## Read and follow all instructions

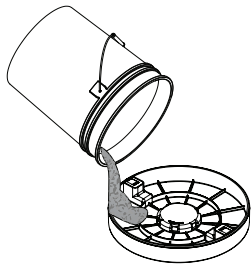

1. Insert supplied plaster shields. Pour the desired material into the fillable side of the lid.

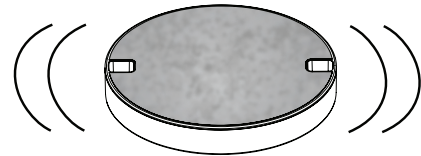

2. Agitate to settle and remove air bubbles in the material.

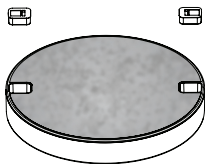

3. Remove plaster shields.

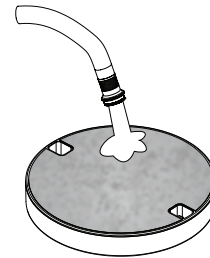

4. Gently wash to clean excess material from the lid, then let dry.

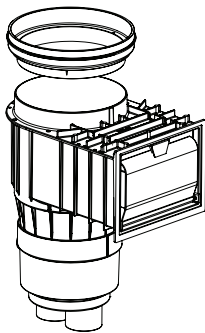

5. Place frame on skimmer and set to desired elevation and level.

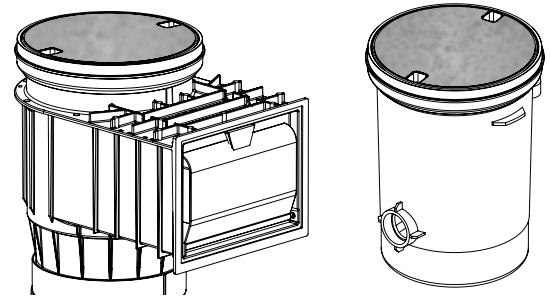

6. Install and secure lid to the frame with provided screws.



2200 East Sturgis Road, Oxnard CA 93030 • Phone 805.981.0262 • Fax 805.981.9403

www.waterwayplastics.com • waterway@waterwayplastics.com