

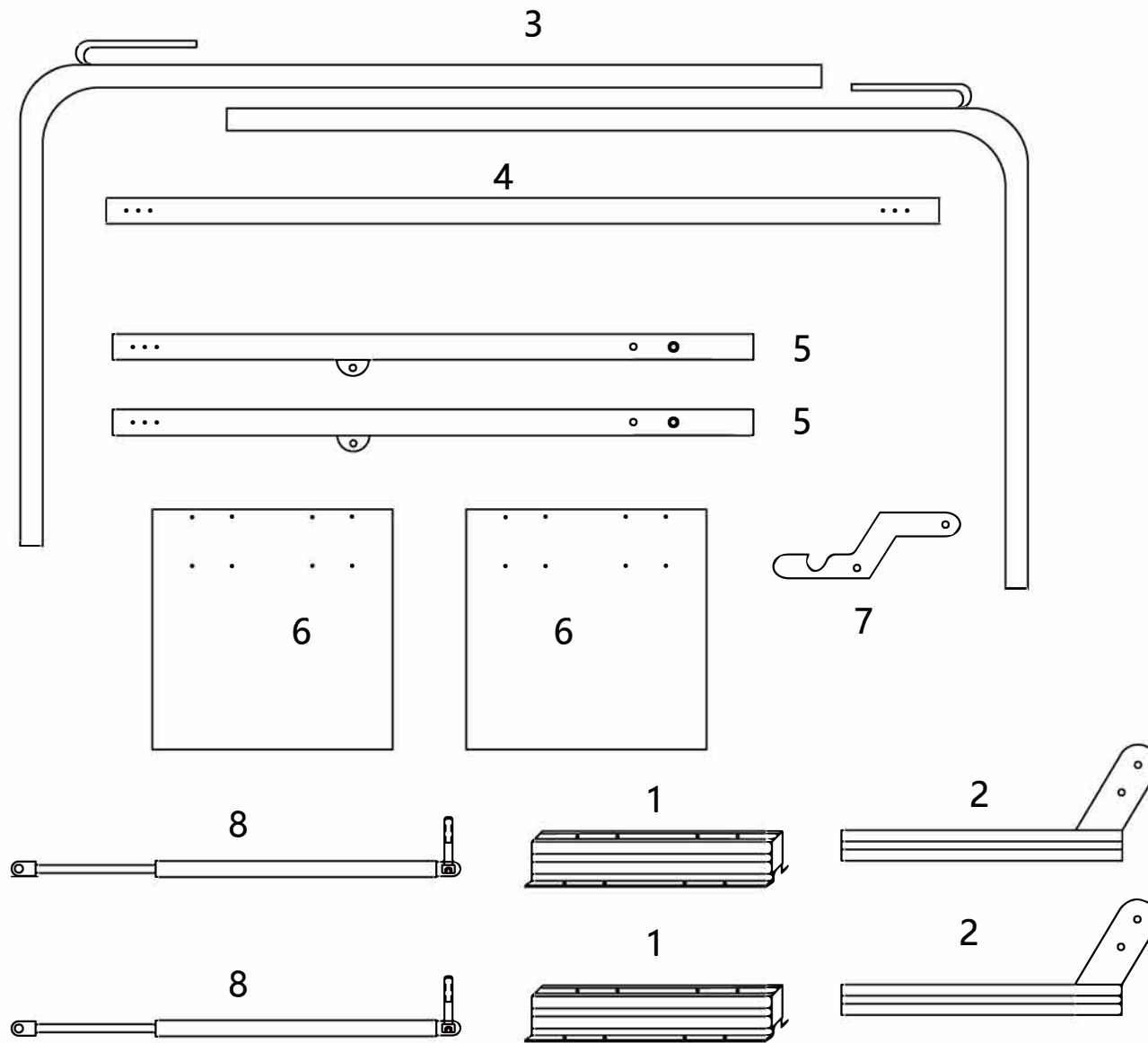









sx-L-09 Installation Instructions



-  M8 = 2
-  5*40=20
-  8*75=4
-  6*16=16
-  5*16=22
-  M6 = 16
-  8*13=6
-  42
-  4

Fix part 1 on both sides of the spa with 5x40 screws.
 Part 2 fits inside Part 1 and is fixed with 5x16 screws

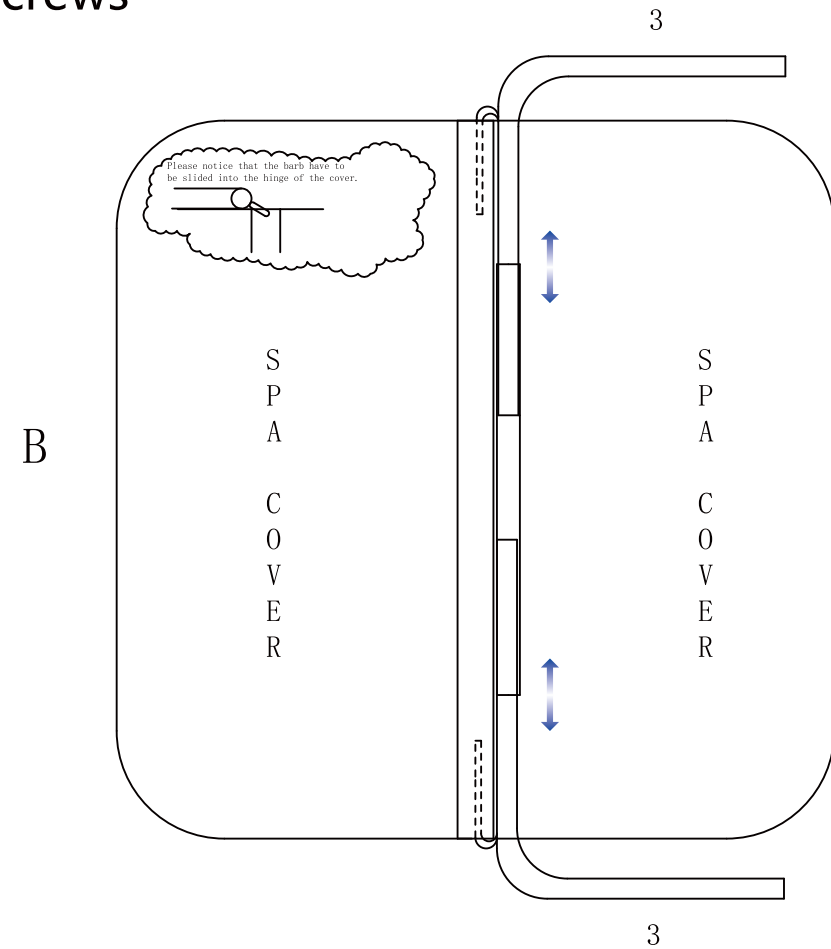
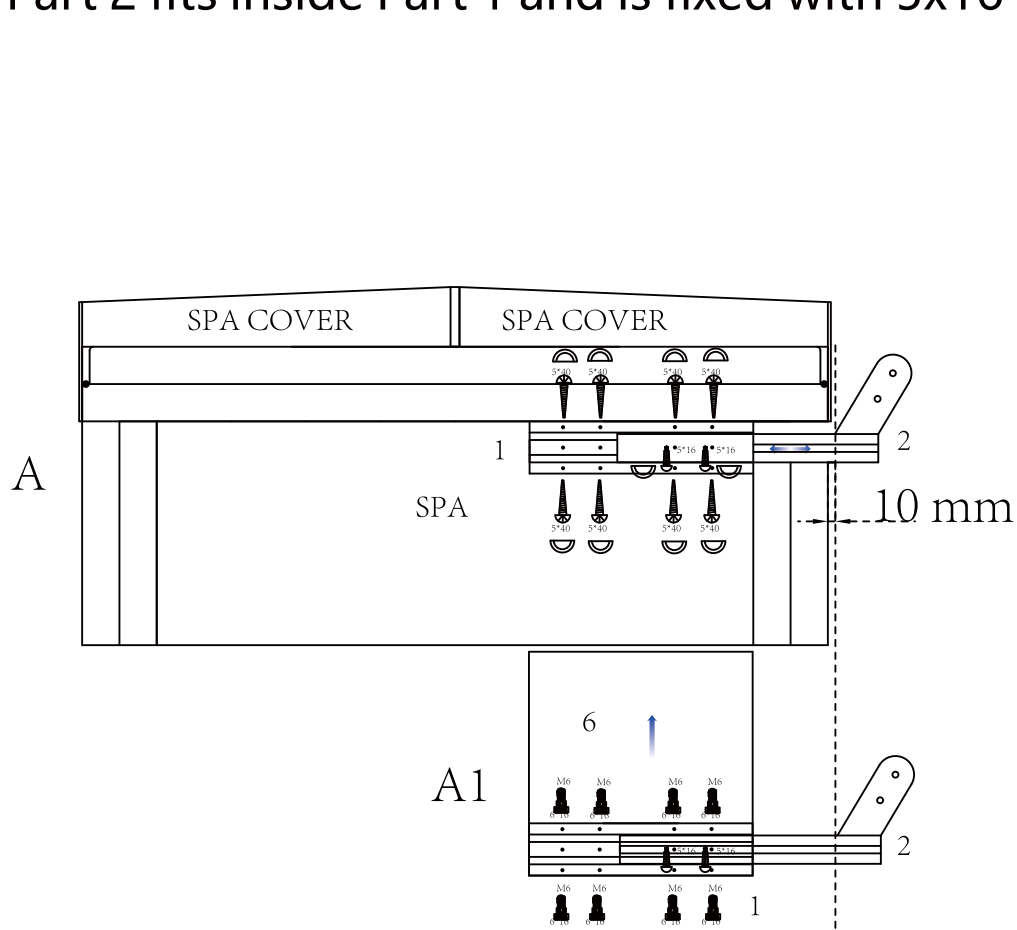

Part 4 and two parts 3 are assembled
 on the insulation cover.

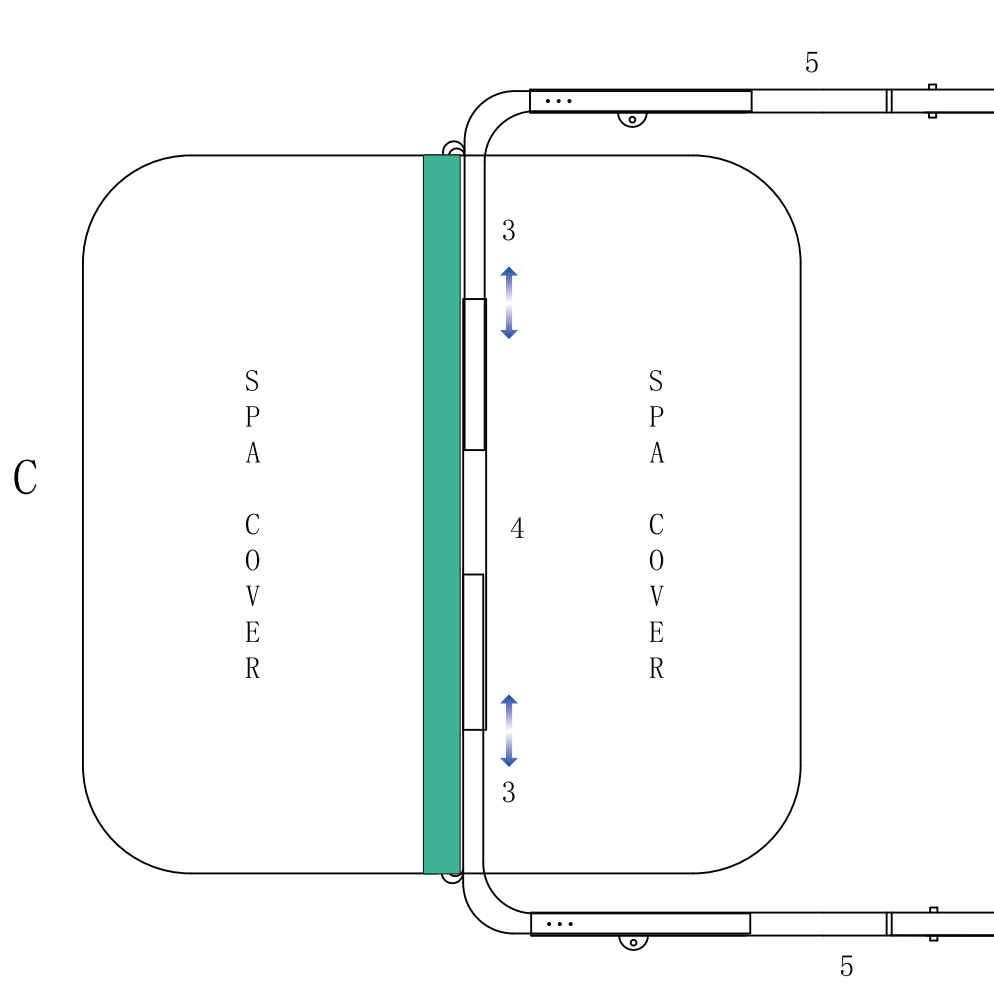

Two parts 5 are assembled separately on both sides of part 3

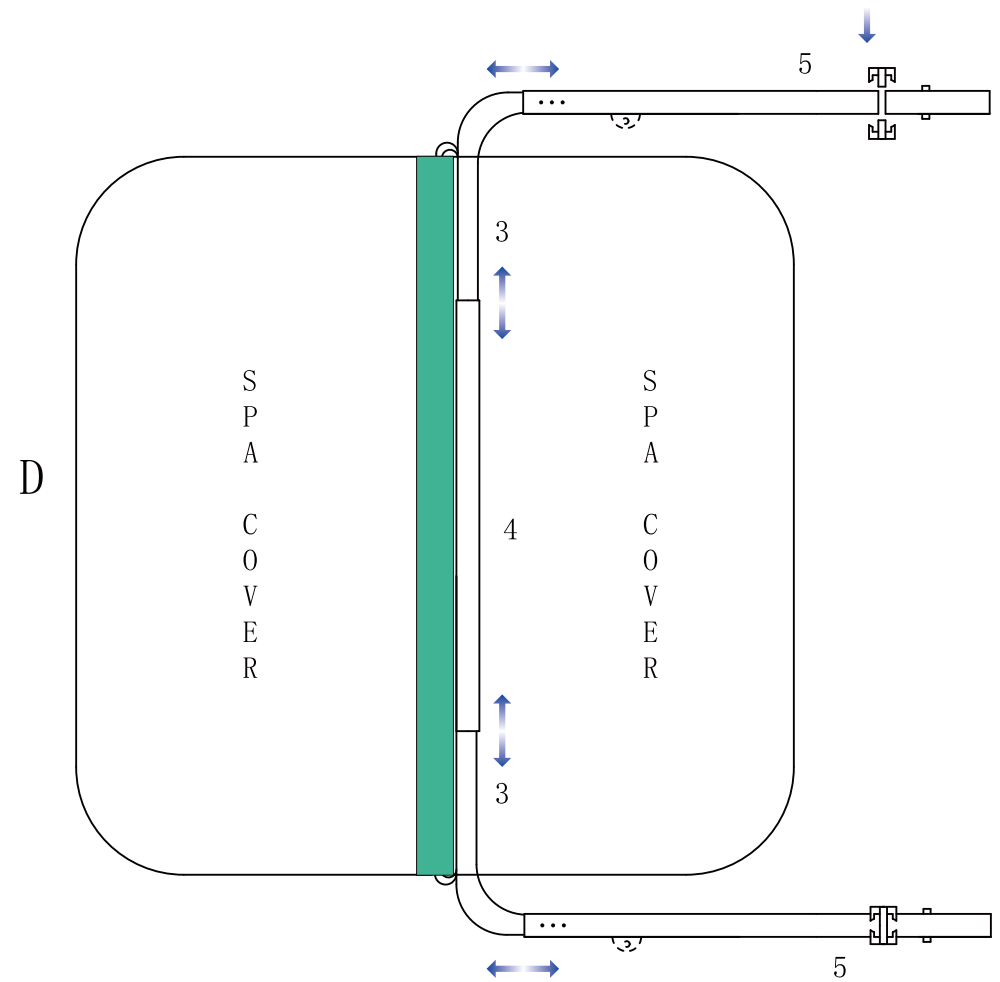

Two  assemble with part 5

Assembly of parts 5 and 2 on both sides

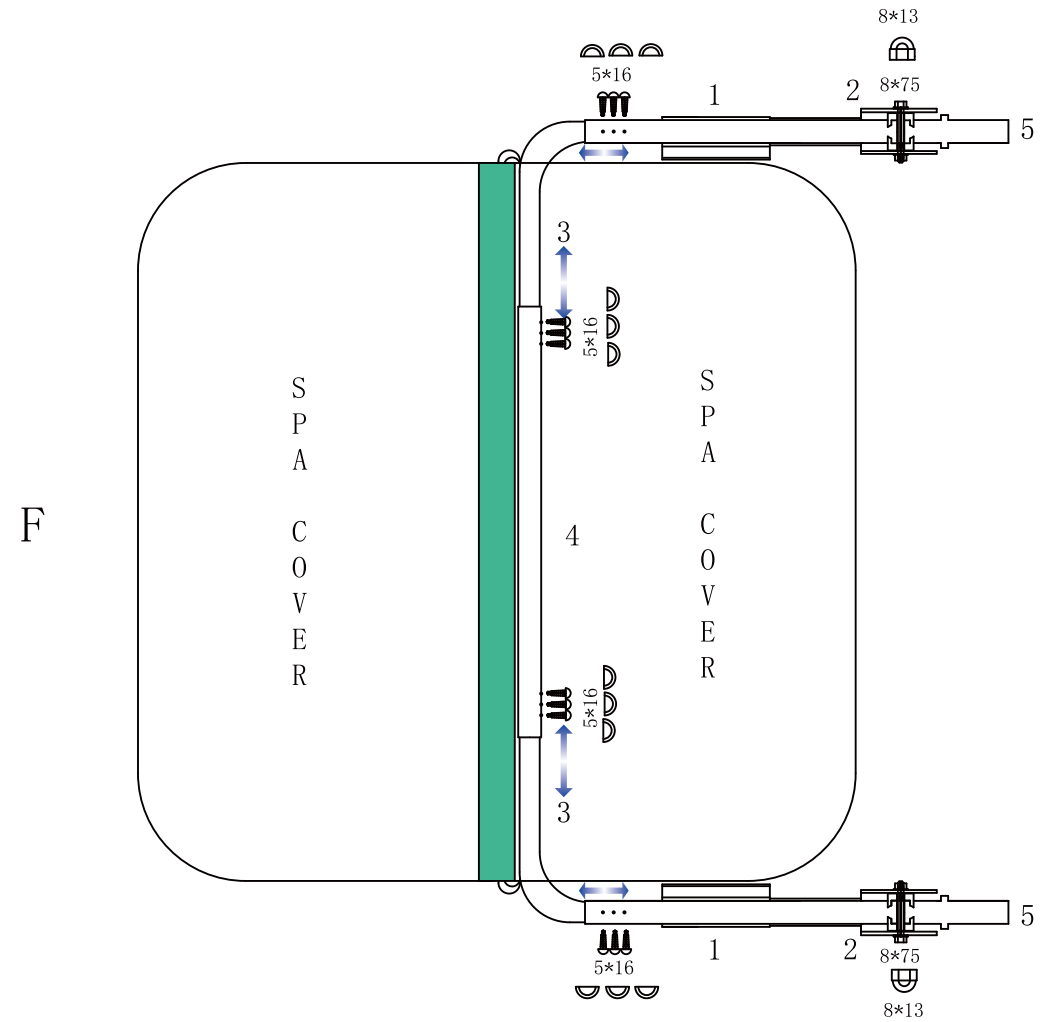
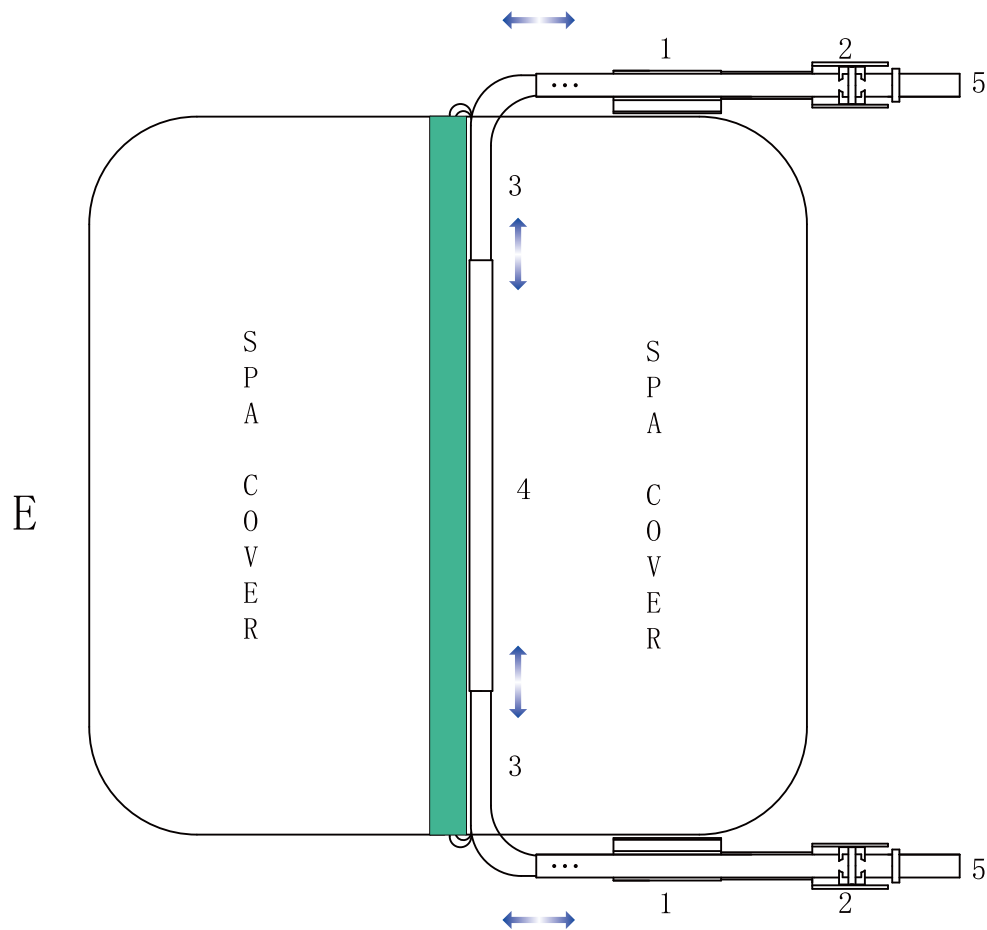

After selecting the appropriate position, fix it with screws, and select the screw cap as shown in the figure

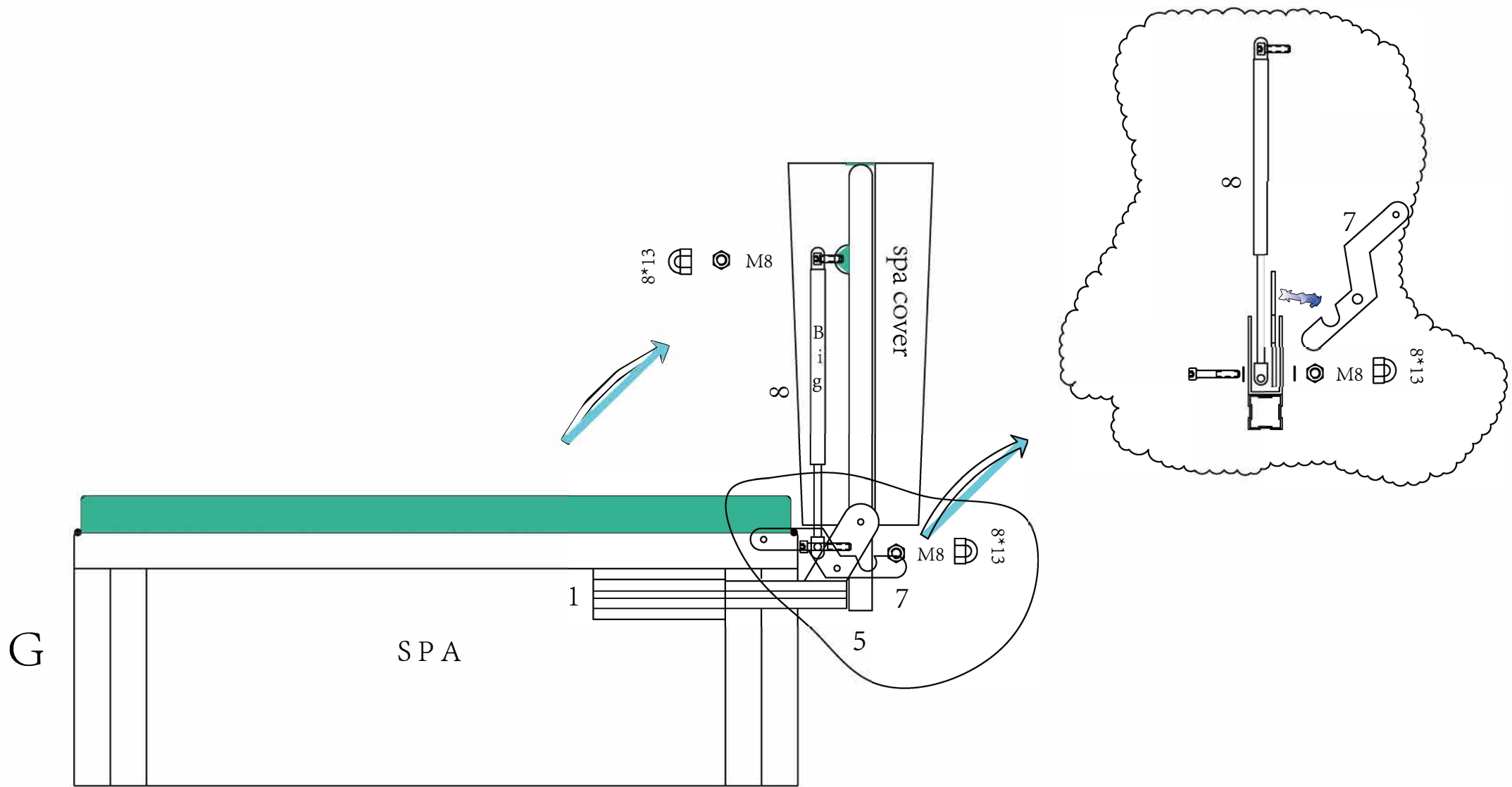

After lifting the insulation cover vertically,
Reinstall the air support rod

Locking lever 7 must be released before closing the cover

Installation method 2

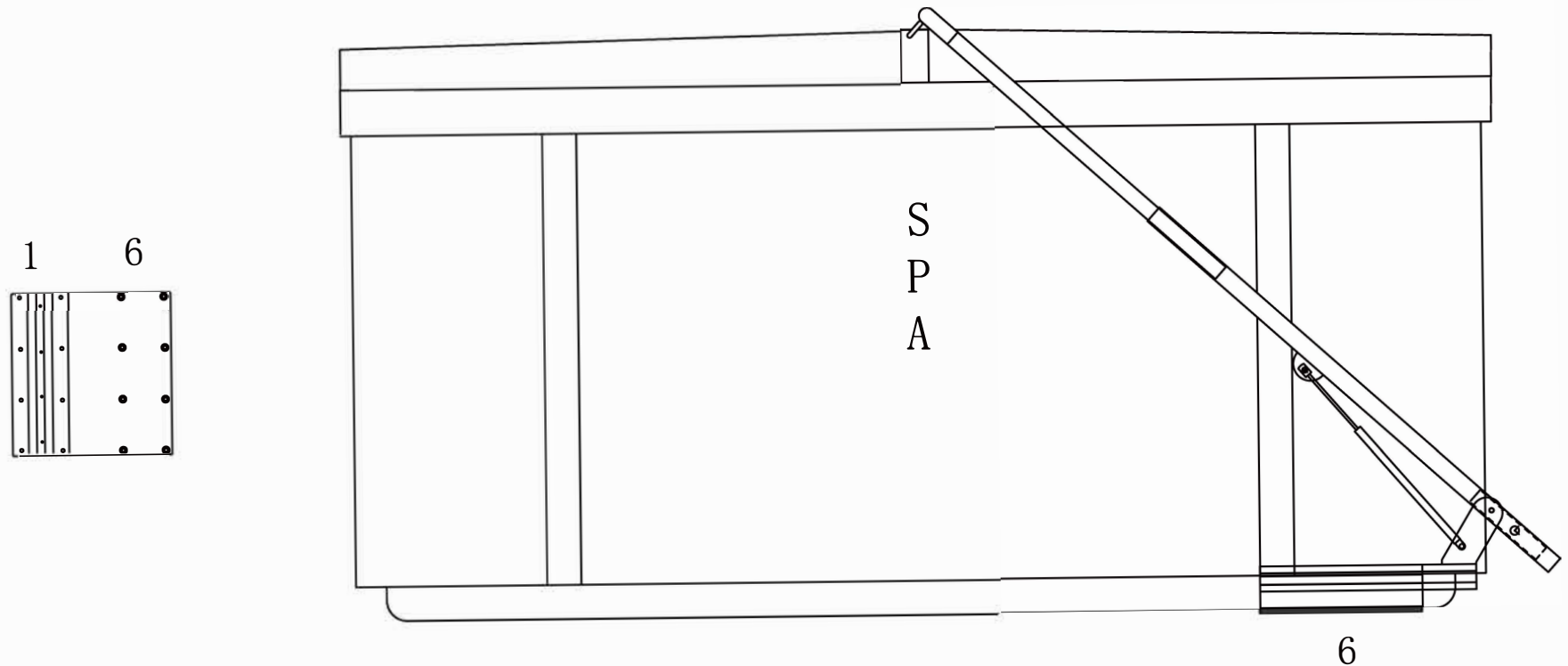

Note - if installed with the undermount bracket or direct to a conductive surface (including undermount bracket sitting on concrete under the spa), this cover lifter must be earth bonded by your electrician.