



INSTRUCTION MANUAL

MT777

AC/DC TRMS CLAMP METER with Datalogger & Mobile APP



Contents	Page no
1. Introduction	4
1.1. Bluetooth Operation.....	4
2. Safety	5
3. Description	6
3.1. Meter Description	6
3.2. Symbols Used on LCD Display	7
3.3. Key Description	7
4. Specifications	8
4.1. AC/DC Current Measurements	8
4.2. Inrush Current Measurements	9
4.3. AC/DC Voltage Measurements	9
4.4. AC+DC Voltage Measurements	10
4.5. Frequency Measurements	10
4.6. VFD Mode.....	10
4.7. LoZ AC Voltage Measurements	11
4.8. Resistance Measurements	11
4.9. Continuity Check	12
4.10. Diode Test	12
4.11. Capacitance Measurements	13
4.12. Temperature Measurements	13
4.13. Flexible Coil Current Measurements.....	14
4.14. Using RANGE	14
4.15. Hold Mode	15
4.16. Capturing Minimum and Maximum Values.....	15
4.17. Relative Values	15
4.18. Capturing Peak Values.....	15
4.19. Non-Contact AC Voltage Measurement.....	16
5. Menu Operation	17
5.1. Settings Details	17
5.2. Data/Time Details.....	17
5.3. Measurement Details	18
5.4. Recording Details	18
5.5. Meter Info Details	20
5.6. Factory Set Details.....	20
6. Maintenance	20
6.1. Cleaning and Storage	20
6.2. Battery Replacement.....	20
6.3. Temperature Probe Replacement.....	20
7. Specifications	21
7.1. Specifications	21
7.2. General Specifications.....	23

1. Introduction

The MT777 1000A AC/DC TRMS Bluetooth Clamp Meter has a CAT IV 600V rating and a 6000 count TFT colour display with an analogue bargraph that provides a fast sampling time with high accuracy. The meter has a built in Data logger with 100 Graph Data review, using Bluetooth, the meter wirelessly transmits data to the Android or iOS mobile App allowing the user to view, save, organise and share recordings.

The VFD function allows the user to measure stable voltage in high frequency applications, while the Low Z range function has a low pass filter to eliminate errors caused by "Ghost" voltages. The meter measures 1000V AC/DC, temperature, frequency, capacitance and resistance measurements, plus 100ms Inrush current and Peak Hold.

Using the optional MT740 True RMS Flexible Clamp Adaptor, the measuring range can be extended to measure 3000A AC. This Bluetooth Clamp Meter has added features such as Non-Contact voltage detection, Data hold function and a built-in flashlight for dimly lit areas. Housed in a modern double moulded rubber housing.

1.1. Bluetooth Operation

- Download the **Major Tech METER-X** app on iOS & Android devices.
- On the MT777, turn the Bluetooth setting ON:
 - Press the MENU Button to open the main menu.
 - Press the MODE button to enter into the setup options.
 - Press the MENU button to move down the setup option list until bluetooth is highlighted.
 - Press the MODE/ENTER button to select the bluetooth option.
 - Press the MENU button once to turn Bluetooth ON.
 - Press the MODE/ENTER button to confirm that Bluetooth is turned ON.
 - Press REL/ESC button to exit the main menu.
- On your mobile device, open the METER-X app and connect the meter to the app. You will be able to record live measurements and save them onto your app.
- On the Meter-X app, visit the help section via the settings menu for further assistance on using the app.



2. Safety

2.1. International Safety Symbols



This symbol, adjacent to another symbol or terminal, indicates the user must refer to the manual for further information.



This symbol, adjacent to a terminal, indicates that, under normal use, hazardous voltages may be present.



Double insulation.

2.2. SAFETY NOTES

- Do not exceed the maximum allowable input range of any function.
- Do not apply voltage to meter when resistance function is selected.
- Set the function switch OFF when the meter is not in use.
- Remove the battery if meter is to be stored for longer than 60 days.

2.3. WARNINGS

- Set function switch to the appropriate position before measuring.
- When measuring volts do not switch to current/resistance modes.
- Do not measure current on a circuit where voltage exceeds 600V.
- When changing ranges always disconnect the test leads from the circuit under test.

2.4. CAUTIONS

- Improper use of this meter can cause damage, shock, injury or death. Read and understand this user manual before operating the meter.
- Always remove the test leads before replacing the battery or fuses.
- Inspect the condition of the test leads and the meter itself for any damage before operating the meter. Repair or replace if damaged before use.
- Use great care when making measurements if the voltages are greater than 25VAC rms or 35VDC. These voltages are considered a shock hazard.
- Always discharge capacitors and remove power from the device under test before performing Diode, Resistance or Continuity tests.
- Voltage checks on electrical outlets can be difficult and misleading because of the uncertainty of connection to the recessed electrical contacts. Other means should be used to ensure that the terminals are not "live".
- If the equipment is used in a manner not specified by the manufacturer, the protection provided by the equipment may be impaired.

3. Description

3.1. Meter Description

- 1-Current Clamp
- 2-Non-Contact AC Voltage Indicator Light
- 3-Clamp Trigger
- 4-Relative/INRUSH/ESC Button
- 5-LCD Display
- 6-MODE/VFD Button
- 7-RANGE Button

- 8-MENU Button
- 9-Rotary Function Swith
- 10-Data Hold/Flashlight Button
- 11-Battery Cover
- 12-COM Input Jack
- 13-VΩHz% CAP TEMP Jack
- 14-Flashlight

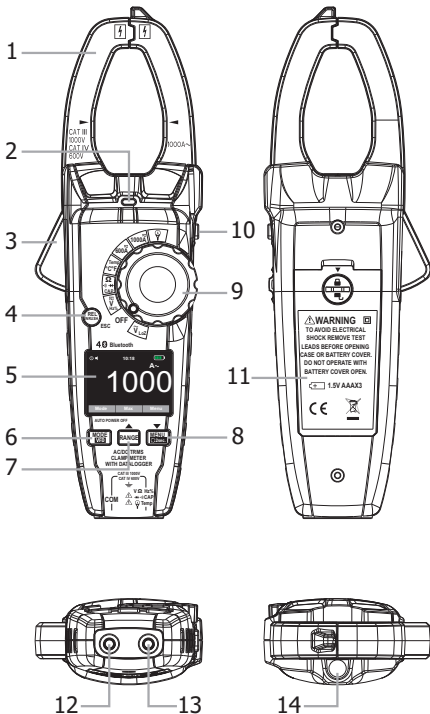

3.2. Symbols Used on LCD Display

1. Power Off Function
2. Key Beeper Function
3. Bluetooth Function
4. Automatic/Manual Mode
5. System's Time
6. Battery Capacity
7. Measuring Unit
8. Measuring Result
9. Analogue Bar Graph
10. Function Keys

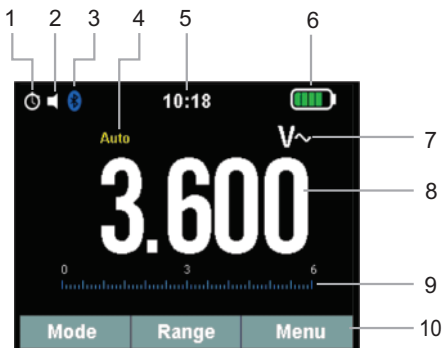

3.3. Key Description

1. **MODE:** Press the Mode key to switch the functions, and press for 2 seconds to switch to VFD AC Voltage when AC Voltage measurement.
2. **RANGE:** Press the Range key for manual range, and press for 2 seconds to switch to auto range measurement.
3. **MENU:** Press the menu key to open the menu functions, and press the range and menu soft key function for more measurement options.
4. **REL:** Press the Rel key for 2 seconds to switch to inrush function when measuring 600 or 1000 A AC.
5. **HOLD:** Freezes the present reading in the display and allows the display to be saved. Press for 2 seconds to turn the Flashlight on or off.

4. Operation

NOTES: Read and understand all Warning and Caution statements in this operation manual prior to using this meter.

NOTES: Set the function select switch to the OFF position when the meter is not in use.

4.1. AC/DC Current Measurements

WARNING: Ensure that the test leads are disconnected from the meter before making current clamp measurements.

1. Set the Function switch to the **1000A, 600A** range, If the approx. range of the measurement is not known, select the highest range then move to the lower ranges if necessary.
2. Use the **MODE** button to select AC or DC.
3. Press the **REL** button to zero the meter display.
4. Press the trigger to open jaw. Fully enclose only one conductor. For optimum results, center the conductor in the jaw.
5. The clamp meter LCD will display the reading.



Incorrect



Correct

4.2. Inrush Current Measurements

1. Set the function switch to the **600A** or **1000A** position.
2. Press the **INRUSH** button (Enter key for 2 seconds) to indicate "Inrush" on the display. Then measurement display "----" .
3. Clamp the cable to the motor.
4. Start the motor.
5. Read the inrush current in the display.

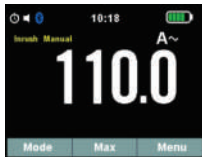

4.3. AC/DC Voltage Measurements

WARNING: Risk of Electrocutation. The probe tips may not be long enough to contact the live parts inside some 240V outlets for appliances because the contacts are recessed deep in the outlets. As a result, the reading may show 0 volts when the outlet actually has voltage on it. Make sure the probe tips are touching the metal contacts inside the outlet before assuming that no voltage is present.

CAUTION: Do not measure AC/DC voltages if a motor on the circuit is being switched ON or OFF. Large voltage surges may occur that can damage the meter.

1. Set the function switch to the **V AC/DC** position.
2. Insert the black test lead banana plug into the negative **COM** jack. Insert the red test lead banana plug into the positive **V** jack.
3. Press the **MODE** key to switch AC or DC Voltage functions.
4. Read the voltage in the display.

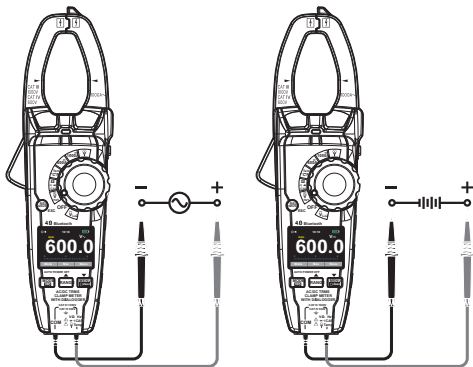

4.4. AC+DC Voltage Measurements

CAUTION: Do not measure DC voltages if a motor on the circuit is being switched ON or OFF. Large voltage surges may occur that can damage the meter.

1. Set the function switch to the **V AC/DC** position.
2. Insert the black test lead banana plug into the negative **COM** jack. Insert the red test lead banana plug into the positive **V** jack.
3. Press the **MODE** key to switch the V AC+DC Voltage functions.
4. Read the AC+DC voltage in the display.

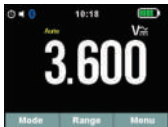

4.5. Frequency Measurements

1. Set the function switch to the **V AC/DC** position.
2. Insert the black test lead banana plug into the negative **COM** jack. Insert the red test lead banana plug into the positive **V** jack.
3. Press the **menu** key for 2 seconds, refer to the soft key function for more measurement options.
4. Press the soft key Hz key to switch the Hz functions.
5. Read the Frequency in the display.
6. Press the soft key Hz to switch the Duty functions.
7. Read the Duty in the display.

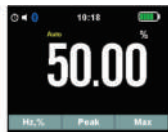
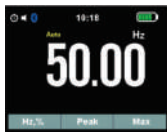

4.6. VFD Mode (Variable Frequency Drive)

1. Set the function switch to the **V AC/DC** to AC Voltage measurements.
2. Press the **VFD** button (MODE key for 2 seconds) to indicate "VFD" on the display for variable frequency driver measurements.
3. Read Measurement in the display



4.7. LoZ AC Voltage Measurements

WARNING: Risk of Electrocution. The probe tips may not be long enough to contact the live parts inside some 240V outlets for appliances because the contacts are recessed deep in the outlets. As a result, the reading may show 0 volts when the outlet actually has voltage on it. Make sure the probe tips are touching the metal contacts inside the outlet before assuming that no voltage is present.

CAUTION: Do not measure AC voltages if a motor on the circuit is being switched ON or OFF. Large voltage surges may occur that can damage the meter.

1. Set the function switch to the **VAC LoZ** position.
2. Insert the black test lead banana plug into the negative **COM** jack. Insert red test lead banana plug into the positive **V** jack.
3. Read the voltage in the main display.



4.8. Resistance Measurements

To avoid electric shock, disconnect power to the unit under test and discharge all capacitors before taking any resistance measurements. Remove the batteries and unplug the line cords.

1. Set the function switch to the Ω \rightarrow **CAP** position.
2. Insert the black test lead banana plug into the negative **COM** jack. Insert the red test lead banana plug into the positive Ω Jack.
3. Read the resistance in the display. If the circuit is open, the display will indicate "OL".

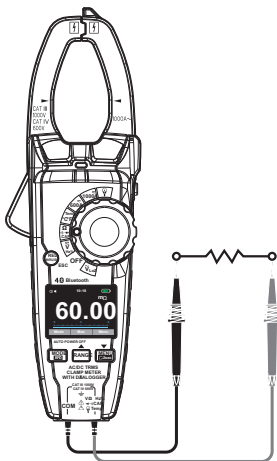

4.9. Continuity Check

WARNING: To avoid electric shock, disconnect power to the unit under test and discharge all capacitors before taking any resistance measurements. Remove the batteries and unplug the line cords.

1. Set the function switch to the Ω \rightarrow CAP position.
2. Insert the black test lead banana plug into the negative **COM** jack. Insert the red test lead banana plug into the positive jack.
3. Press the **MODE** key to switch the continuity functions.
4. If the resistance is less than approximately 50Ω , the audible signal will sound. If the circuit is open, the display will indicate "OL".

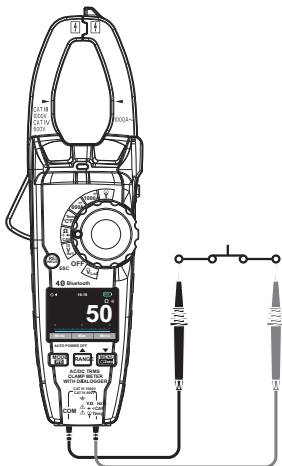

4.10. Diode Test

1. Set the function switch to the Ω \rightarrow CAP position.
2. Insert the black test lead banana plug into the negative **COM** jack and the red test lead banana plug into the positive **V** jack.
3. Press the **MODE** key to switch the Diode functions.
4. Forward voltage will typically indicate 0.400 to 3.000V. Reverse voltage will indicate "OL". Shorted devices will indicate near 0V and an open device will indicate "OL" in both polarities.

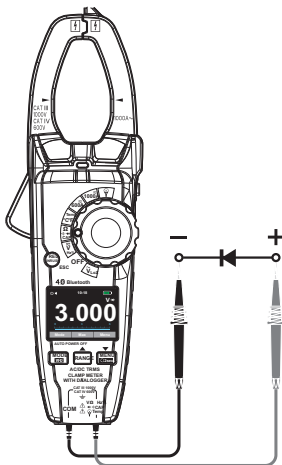

4.11. Capacitance Measurements

WARNING: To avoid electric shock, disconnect power to the unit under test and discharge all capacitors before taking any capacitance measurements. Remove the batteries and unplug the line cords.

1. Set the rotary function switch to the Ω \rightarrow **CAP** position.
2. Insert the black test lead banana plug into the negative **COM** jack. Insert the red test lead banana plug into the positive **V** jack.
3. Press the **MODE** button to switch the Capacitance functions.
4. Read the capacitance value in the Display.

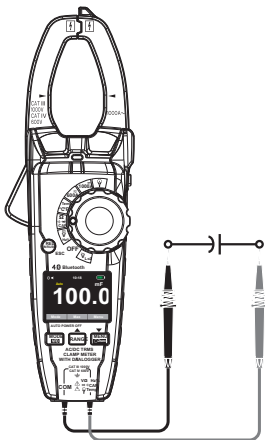

4.12. Temperature Measurements

1. Set the function switch to the **TEMP** position.
2. Insert the Temperature Probe into the input jacks, making sure to observe the correct polarity.
3. Read the temperature in the display.
4. Press the **MODE** key to switch the Unit ($^{\circ}\text{C}$ or $^{\circ}\text{F}$).

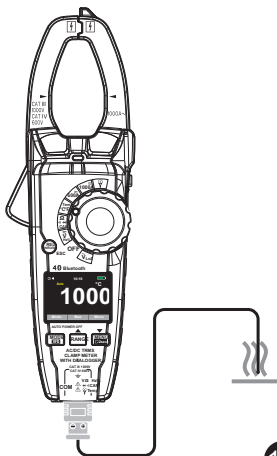

4.13. Flexible Coil Current Measurements (use the MT740)

1. Set the function switch to the Flexible coil position.
2. Insert the black test lead banana plug into the negative **COM** jack. Insert the red test lead banana plug into the positive **V** jack.
3. Read the Current in the display.
4. Press the **RANGE** key to switch range. 30A, 300A, 3000A.

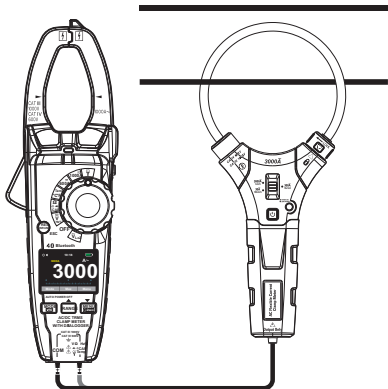

4.14. Using RANGE

- Press the **RANGE** key to activate the manual mode and to disable the Auto range function.
- The message "Manual" appears on the upper left part of the display instead of "Auto".
- In manual mode, press the **RANGE** key to change measuring range: the relevant decimal point will change its position.
- The **RANGE** key is not active in positions μ , m , $\%$, Temp $^{\circ}\text{C}/^{\circ}\text{F}$, 600A ACDC, 1000A ACDC.
- In Auto range mode, the instrument selects the most appropriate ratio for carrying out measurement.
- If a reading is higher than the maximum measurable value, the indication "O.L." appears on the display.
- Press and hold the **RANGE** key for more than 1 second to exit the manual mode and restore the Auto range mode.

Auto (or manual) mode fig below:

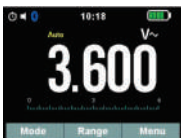

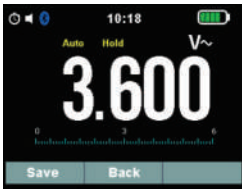

4.15. Hold Mode

- To freeze the display for any function, press key **HOLD**. And again press key **HOLD** to release freeze.
- Press soft key **SAVE** will store the measurement to memory.

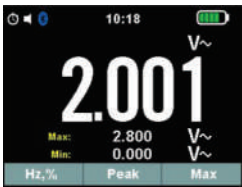

4.16. Capturing Minimum and Maximum Values

- The MAX MIN Record mode captures minimum, and maximum input values.
- When the input goes below the recorded minimum value or above the recorded maximum value, the Meter beeps and records the new value.
- This mode is for capturing intermittent readings, recording minimum and maximum readings unattended, or recording readings while equipment operation precludes watching the Meter.
- To activate the MAX MIN mode, press soft key **max**.
- If the Meter is already in MAX MIN function, press **max** to turn MAX MIN function off.



4.17. Relative Values

- To activate the relative mode, press the **REL** key.
- If the Meter is already in the relative function, press **REL** to turn REL MODE off.



4.18. Capturing Peak Values

- In VAC measures, To activate the peak mode, press the soft key **peak**.
- If the Meter is already in the peak function, press **peak** to turn Peak mode off.

4.19. Non-Contact AC Voltage Measurement

WARNING: Risk of Electrocution. Before use, always test the voltage detector on a known live circuit to verify proper operation.

1. Touch the probe tip to the live conductor or insert into the live side of the electrical outlet.
2. If AC voltage is present, the detector light will illuminate.

Note: The conductors in electrical cord sets are often twisted. For best results, move the probe tip along a length of the cord to assure placing the tip in close proximity to the live conductor.

Note: The detector is designed with high sensitivity. Static electricity or other sources of energy may randomly activate the sensor. This is normal operation.

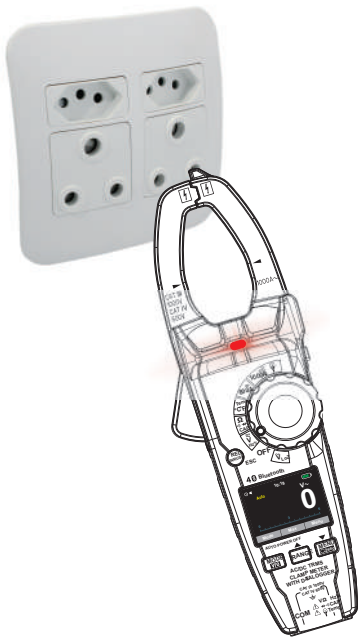

5. Menu Operation

- Press Menu button to open the Menus, As show below
- Press soft key **Up / Down** to select menu item or change the value of current focus item.
- Press soft key Enter to enter the submenu or set focus on the current selected item.
- Press ESC button to return to the previous menu.



5.1. Settings Details

- Press soft key **Up/Down** to select setup item at main menu, and Press soft key Enter to enter.
- Four options are available: Key Sound, Bluetooth, 12 Hour and APO Time.
 - 1.Key Sound: Use **Up/Down** button to set beep on or off.
 - 2.Bluetooth: Use **Up/Down** button to turn Bluetooth on or off.
 - 3.12 Hour: Use **Up/Down** button to set Time 12 Hour on or 24 Hour.
 - 4.APO Time: Use **Up/Down** button to set Auto Power Off Time 15,30,45,60,and off.

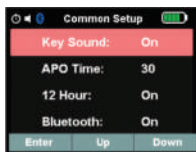

5.2. Data/Time Details

- Press soft key **Up/Down** to select Data/Time item at main menu, and Press soft key Enter to enter.
- In this menu, year, month, day, hour, minute can be set.



5.3. Measurement Details

- Press soft key **Up/Down** to select Measurement item at Measurement menu, and Press soft key Enter to enter the menu.

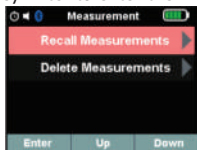

- This recalls all the measurements saved when the hold button was used and the readings were saved, refer to 4.15 (Hold Mode)
- Recall Measurement Item can Recall store measurement in Memory.
- Delete Measurements item will Delete all data in Memory.
- Recall measurement fig is below:

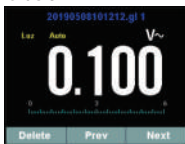

5.4. Recording Details

1. Press soft key **Up/Down** to select Recording item at main menu, and press soft key Enter to enter Recording Function. Recording Menu is below:



2. In Recording Menu. Press soft key **Up/Down** to select Setup New Recording Item, and press soft key Enter to enter set Duration and sample time. fig is below:

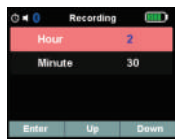
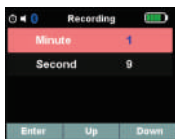
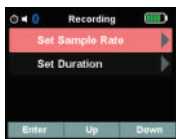

3. In Record Menu. Press soft key **Up/Down** to select Start recording Item, and press soft key Enter to start one new recording.

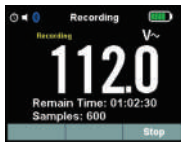

4. In Record Menu. Press soft key **Up/Down** to select Recall recordings Item, and press soft key Enter to enter recall recording in memory. Then Press soft key Prev/Next view last or next recording. Fig is below:

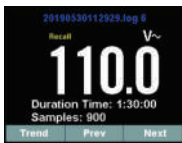

And Press soft key Trend to expansion graph. Fig is below:

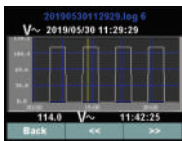

5. In Record Menu. Press soft key **Up/Down** to select Delete recordings Item. and press soft key Enter to enter delete all recording function.

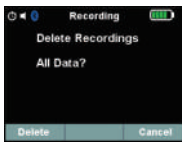

5.5. Meter Info Details

- Press soft key **Up/Down** to select Meter Info item at main menu, and Press soft key Enter to enter Meter info interface.
- This menu contains software's version, hardware's version and Free Memory.



5.6. Factory Set Details

- Press soft key **Up/Down** to select Factory set item at main menu, and Press soft key Enter to enter Factory set interface.
- Select "YES" button, System setting will be reset. Fig is below:



6. Maintenance

WARNING: To avoid electrical shock, disconnect the meter from any circuit, remove the test leads from the input terminals, and turn OFF the meter before opening the case. Do not operate the meter with an open case.

6.1. Cleaning and Storage

- Periodically wipe the case with a damp cloth and mild detergent; do not use abrasives or solvents.
- If the meter is not to be used for 60 days or more, remove the battery and store it separately.

6.2. Battery Replacement

1. Remove the Phillips head screw that secures the rear battery door.
2. Open the battery compartment.
3. Replace the AAA battery.
4. Secure the battery compartment.

6.3. Temperature Probe Replacement

Note: To use a Type K thermocouple probe that is terminated by a subminiature (flat blade) connector, a subminiature-to-banana plug adaptor is required.

7. Specifications

7.1. Specifications

Accuracy calculated as [%reading + (num. digits*resolution)] at 18 to 28°C; <75%HR.

Function	Range	Resolution	Accuracy
DC Voltage	600.0mV	0.1mV	$\pm(0.5\% + 8 \text{ digits})$
	6.000V	0.001V	$\pm(1.5\% + 5 \text{ digits})$
	60.00V	0.01V	
	600.0V	0.1V	
	1000V	1V	

Input impedance >10M Ω ; Protection against overcharge: 1000VDC/AC RMS.

AC TRMS Voltage (50Hz-400Hz)	6.000V	0.001V	$\pm(1.5\% + 5 \text{ digits})$
	60.00V	0.01V	
	600.0V	0.1V	
	1000V	1V	

Input impedance >9M Ω ; Protection against overcharge: 1000VDC/AC RMS.
Accuracy specified from 10% to 100% of the measuring range, sine wave.
Accuracy PEAK function: $\pm 10\%$ rdg, PEAK response time: 1ms.
VFD AC Voltage reading for reference only.

LowZ AC TRMS Voltage (50Hz-400Hz)	6.000V	0.001V	$\pm(3.0\% + 40 \text{ digits})$
	60.00V	0.01V	
	300.0V	0.1V	

Input impedance <300k Ω ; Protection against overcharge: 1000VDC/AC RMS.
Accuracy specified from 10% to 100% of the measuring range, sine wave.

AC+DC TRMS Voltage (50Hz-400Hz)	6.000V	0.001V	$\pm(2.5\% + 20 \text{ digits})$
	60.00V	0.01V	
	600.0V	0.1V	
	1000V	1V	

Input impedance >10M Ω ; Protection against overcharge: 1000VDC/AC RMS.

DC Current	600.0A	0.1A	$\pm(2.5\% + 5 \text{ digits})$
	1000A	1A	$\pm(2.8\% + 5 \text{ digits})$

Protection against overcharge: 1000ADC/AC RMS.

AC TRMS Current (50Hz-60Hz)	600.0A	0.1A	$\pm(2.5\% + 5 \text{ digits})$
	1000A	1A	$\pm(2.8\% + 5 \text{ digits})$

Protection against overcharge: 1000ADC/AC RMS.

Flexible Coil Current (50Hz-400Hz)	30.00A	0.01A	$\pm(3.0\% + 5 \text{ digits})$
	300.0A	0.1A	
	3000A	1A	

Protection against overcharge: 3000ADC/AC RMS.
Accuracy specified from 10% to 100% of the measuring range, sine wave.

Function	Range	Resolution	Accuracy
Resistance and Continuity Test	600.0Ω	0.1Ω	±(1.0% + 10 digits)
	6.000kΩ	0.001kΩ	±(1.5% + 5 digits)
	60.00kΩ	0.01kΩ	
	600.0kΩ	0.1kΩ	
	6.000MΩ	0.001MΩ	±(2.5% + 5 digits)
60.00MΩ	0.01MΩ	±(3.5% + 10 digits)	

Buzzer <50Ω; Protection against overcharge: 1000VDC/AC RMS.

Diode Test	Test Current<1.5mA Max voltage with open circuit: 3.3VDC
------------	-------------------------------------------------------------

Frequency (Electronic circuits)	Range	Resolution	Accuracy
	9.999Hz-99.99 kHz	0.01-10Hz	±(1.2% + 5 digits)

Protection against overcharge: 1000VDC/AC RMS.

Sensitivity: >5V RMS (at 20% - 80% duty cycle).

Duty Cycle	Range	Resolution	Accuracy
	10.0% - 90.0%	0.1%	±(1.2% + 8 digits)

Pulse frequency range: 40Hz - 10kHz, Pulse amplitude:±5V (0.1ms - 100ms).

Capacity	Range	Resolution	Accuracy
	60.00nF	0.01nF	±(4.0% + 20 digits)
	600.0nF	0.1nF	±(3.0% + 8 digits)
	6.000μF	0.001μF	
	60.00μF	0.01μF	
	600.0μF	0.1μF	
	6000μF	1μF	±(5.0% + 8 digits)
	60.00mF	0.01mF	±(5.0% + 20 digits)
	100.0mF	0.1mF	

Protection against overcharge: 1000VDC/AC RMS.

Temperature with K-Type Probe	Range	Resolution	Accuracy
	-40.0 to 600.0°C	0.1°C	±(1.5% + 5°C)
	600 to 1000°C	1°C	
	-40.0 to 600.0°F	0.1°F	±(1.5% + 9°F)
	600 to 1800°F	1°F	

Protection against overcharge: 1000VDC/AC RMS.

Instrument accuracy without probe; Specified accuracy with stable environmental temperature at ±1°C.

For long-lasting measurements, reading increases by 2°C.

7.2.General Specifications

Clamp Jaw Opening	33mm approx.
Display	3-5/6 digits (6000 counts) TFT Color LCD
Continuity Check	Threshold 50 Ω ; Test current < 0.5mA.
Diode Test	Test current of 0.3mA typical; Open circuit voltage < 3.3VDC typical.
Over-Range Indication	"OL" display
Measurement Rate	3 readings per second, nominal
Peak	Captures peaks >1ms
Temperature Sensor	Type K thermocouple
Input Impedance	10M VDC and 9M VAC
AC Response	True RMS (AAC and VAC)
Operating Temperature	5 to 40°C (41 to 104°F)
Storage Temperature	-20 to 60°C (-4 to 140°F)
Operating Humidity	Max 80% up to 31°C decreasing linearly to 50% at 40°C
Storage Humidity	<80%
Operating Altitude	2000 meters maximum.
Battery	Three (3) x 1.5V AAA battery
Auto Power Off	After approx. 15-60 minutes.
Dimensions	250 x 78 x 40mm
Weight	350g
Safety	For indoor use and in accordance with the requirements for double insulation to IEC1010-1 (2001): EN61010-1 (2001) Overvoltage Category III 1000V and Category IV 600V, Pollution Degree 2.



MAJOR TECH (PTY) LTD

South Africa

 www.major-tech.com

 sales@major-tech.com

Australia

 www.majortech.com.au

 info@majortech.com.au

